



Andover Continuum™

BACnet™ Family of Controllers

BACnet THAT IS INTELLIGENT . . . AT EVERY LEVEL

Open standards provide building owners with flexibility and choice when selecting building automation technology. The BACnet open standard provides a universal model for creating building automation systems that can interoperate with one another. The Andover Continuum system takes full advantage of BACnet's data sharing, trending, scheduling, alarming, and device management services. From the BACnet Operators Workstation, to the Building Controller, to the simplest terminal controller, the Andover Continuum BACnet family of products provide the highest level of interoperability at every level.

ANDOVER CONTINUUM IS A NATIVE BACnet SYSTEM

To harness the full benefits of BACnet, it is important that the system is native BACnet throughout. Andover Continuum uses BACnet communications at every level of the system. The Andover Continuum system has BACnet Operator Workstations (B-OWS) and the BACnet Building Controllers (B-BC), which are used for system management and BACnet message routing, but these Devices are only a part of the whole Andover Continuum BACnet solution.

It is very important to carry BACnet to a full line of intelligent BACnet MS/TP controllers that contain and run their own programs, BACnet trends, BACnet schedules, and BACnet alarms, thereby increasing your processing power and reliability. If a communications wire is cut, you can be assured that the air handler, chiller, and fan coil unit will remain running under the appropriate schedule, trending the data and storing alarms. Furthermore, your interoperability is greatly increased while lowering installation costs. For example, the same BACnet MS/TP network that is being used by the Andover Continuum BACnet field controllers may be used by a third-party air handler or VFD.

In addition, the open architecture of Andover Continuum permits Andover Continuum's access controllers, lighting controllers, digital video recorders, and 200+ protocol drivers to work with native BACnet Devices from TAC and other third-party BACnet manufacturers.

BTL LISTED BACnet CONTROLLERS

The Andover Continuum family of native BACnet controllers are ready to meet your demanding control applications. As native BACnet controllers, they are listed with the BACnet Testing Laboratories (BTL) as BACnet Building Controllers (B-BC) or BACnet Advanced Application Controllers with trending support (B-AAC + trend) and communicate as MS/TP or BACnet/IP Devices to all other third-party BACnet Devices on the network and attached sub-networks, in strict accordance with ANSI/ASHRAE standard 135-2004.

- Native BACnet/IP or BACnet MS/TP Communications for Interoperability to Third-Party Systems
- Supports 18 BACnet Object Types including Trends, Schedules, Calendar, and Loops
- BACnet Operator Workstation Manages Entire BACnet System
- All Controllers are Completely Programmable with Plain English
- Expandable I/O Meets Additional Point Count Needs
- Non-Volatile Flash Memory Provides Utmost Reliability - Stores Both Applications Program and Operating System
- Flash Memory Allows Easy On-Line Software Updates
- BACnet Service Tool Simplifies Installation and Day-to-Day Maintenance
- BTL Listed B-BC Controllers or B-AAC Controllers all with Local Trends



BACnet Operator Workstations/User Interface

CYBERSTATION

CyberStation is a complete user interface for BACnet networks. It communicates with the BACnet devices using BACnet/IP in strict accordance with ANSI/ASHRAE standard 135-2004 and is designed to function as a BACnet Operator Workstation (B-OWS) and BACnet Broadcast Management Device (BBMD). The CyberStation can communicate to all Andover Continuum BACnet Devices as well as any third-party BACnet Device on the BACnet network.

From CyberStation the entire Andover Continuum system may be configured, programmed, and monitored. CyberStation takes advantage of the self-describing nature of the BACnet protocol. BACnet Devices and objects from any vendor are easily discovered and created in the Andover Continuum SQL database using the "Find BACnet Devices" and "Save to Database" functions. You'll save hours compared with traditional integration requiring known addresses and point-mapping.

CyberStation contains a rich editor for programming Andover Continuum controllers with the Plain English (PE) programming language. This flexible environment allows for the most complex and customer specific sequences to be programmed. PE code can even be written to issue BACnet read/write commands to third-party BACnet Devices, thereby taken control of the foreign controller.

CyberStation is equipped to make use of the other powerful services provided within the BACnet protocol including scheduling, trending, and alarming. Andover Continuum and third-party BACnet Devices may be backed-up and restored using the BACnet backup and restore services providing for quick disaster recovery.

When it comes to monitoring and reporting, CyberStation really shines. Its graphics system is fully featured and provides dynamic updates of point values for any BACnet object on the system. Schedules, trends, reports, and other tools can be launched from a graphic which provides quick, easy access to managing your whole system. CyberStation's graphical reports can display raw log data in many output formats, html text reports, scalable vector graphic (SVG) bar, pie, and line charts, or as an Adobe Acrobat PDF file. Furthermore, data can be represented statistically — the top 10 alarms, the higher temperature values, etc. Reports can be run manually or executed on an alarm or schedule and emailed to a predefined recipient list.

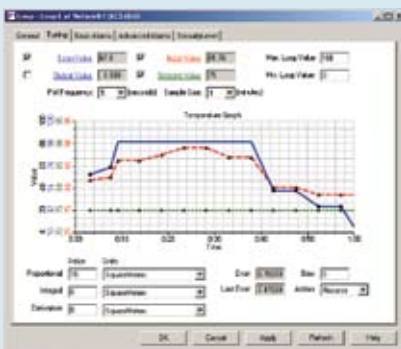
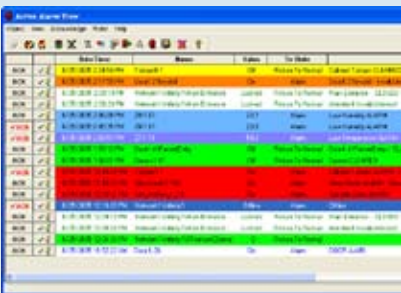
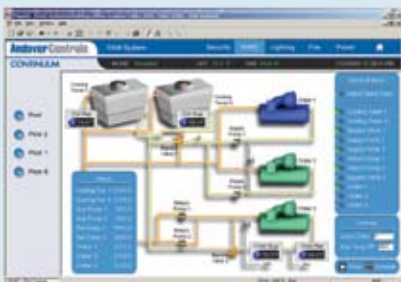

Supports 18 BACnet Object Types:

- Analog Input
- Analog Output
- Analog Value
- Binary Input
- Binary Output
- Binary Value
- Calendar
- Device
- Event Enrollment
- File
- Loop
- Multi-State Input
- Multi-State Output
- Multi-State Value
- Notification Class
- Program
- Schedule
- Trend Log

WEB.CLIENT

web.Client extends the Andover Continuum system to the web. Using the same database as CyberStation, web.Client gives the operator the freedom to access the Andover Continuum BACnet system from anywhere on the network or over Internet. Many of CyberStation's editors and features are available in web.Client as you would use them in CyberStation. web.Client even uses the same graphics as CyberStation so there is no need to create or convert a specific graphic for web use. Furthermore, ad hoc reports may be created while connected to Andover Continuum via web.Client.

EMBEDDED WEB SERVER

Every Andover Continuum controller that resides on an IP Ethernet network contains an embedded web server. The embedded web server provides a simple interface for custom web pages that contain BACnet and Andover Continuum data. A custom web page can permit a user to edit point values and display log data, as well as displaying present values of object properties. The embedded web server also comes with default web pages for controller configuration.

ROAMIO₂ SERVICE TOOL

The RoamIO₂ service tool is the ideal interface for project commissioning and day-to-day maintenance. RoamIO₂ may be used with either a PocketPC or a laptop and can connect to an Andover Continuum system's BACnet/IP or MS/TP network. Furthermore, the RoamIO₂ unit can connect wirelessly to the PocketPC or laptop using a Bluetooth interface. This tool allows the technician to view an Andover Continuum or BACnet point (and its properties) along with many editing capabilities. Disable a fan for maintenance or download a new application to a controller. Since the RoamIO supports BACnet backup and restore, even a third-party controller that supports backup and restore may be reloaded with the RoamIO₂.

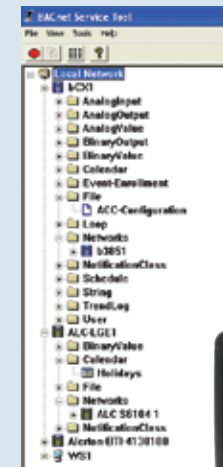
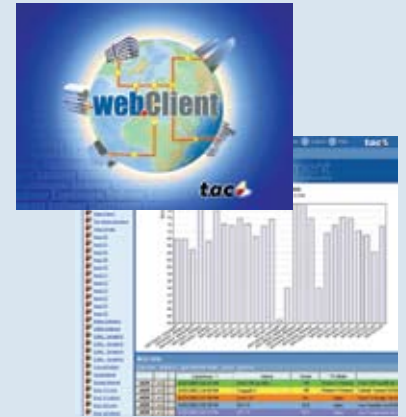

Specifications	CyberStation	web.Client	Embedded Web Server (bCX1)	RoamIO ₂
Native BACnet	Yes	Yes	Yes	Yes
BACnet/IP	Yes	Yes	Yes	Yes
BBMD	Yes	-	bCX1 only	-
BACnet Scheduling	Yes – Full	Yes – Full	-	View
BACnet Trending	Yes – Full	Yes – Full	-	View
BACnet Alarming	Yes – Full	Yes – Full	-	-
BACnet Backup & Restore	Yes	-	-	Yes
Graphics	Yes – Full	Yes – Full	Yes – HTML	-
Configuration	Yes – Full	Yes - Some	Yes - Some	Yes - Some
Programming	Yes – Full	-	-	-
Reporting	Yes – Full	Yes – Full	Yes – HTML	-
User Security	Yes	Yes	Yes	Yes

Building Controller

BCX1 ROUTER/CONTROLLER SERIES



The Andover Continuum bCX1 is a series of Native BACnet routers and controller/routers which heads up the BACnet family of Andover Continuum controllers. These controllers reside at the network level and route BACnet messages between BACnet/IP,

BACnet over Ethernet, and MS/TP networks. The bCX1 can also serve as a BACnet Broadcast Management Device (BBMD) allowing for routing of messages between IP networks.

There are two basic bCX1 models: the bCX1-R (Router Only) and the bCX1-CR (Controller/Router). The bCX1-R model provides all the functionality to route messages between BACnet networks and the bCX1-CR is a full-function BACnet Building Controller (B-BC). The bCX1-CR performs the routing functions of the bCX1-R, with the additional power of a programmable controller with expansion I/O capabilities.

ALL BCX1 MODELS (BCX1-R AND BCX1-CR):

Native BACnet

As Native BACnet controllers developed in strict accordance with the ASHRAE 135-2004 BACnet standard, the bCX1 can communicate directly with other third-party BACnet/IP and BACnet MS/TP devices, as well as all Andover Continuum BACnet devices. The bCX1 also supports BACnet over Ethernet, allowing devices that communicate with the earlier versions of the BACnet Specification to also communicate with BACnet/IP devices.

Easy Configuration

The bCX1 is designed with ease-of-installation in mind. All configuration settings are done via a standard web browser — set the IP address, BACnet address, etc., and save to Flash. All connections to the bCX1 series controller are accomplished with removable connectors for easy installation, providing the ability to pre-wire panels and service the unit simply.

BBMD Support

All bCX1 series devices can be configured to function as BACnet Broadcast Management Devices, or BBMDs. It is the BBMD's job to pass BACnet broadcasts across IP/Routers to other IP segments. As a result of having a BBMD in place, BACnet devices are able to fully communicate via the Internet.

CONTROLLER/ROUTER COMBO MODELS (bCX1-CR)

The bCX1-CR is listed with the BACnet Testing Laboratories (BTL) as a BACnet Building Controller or B-BC, with interoperability BACnet Data Sharing, Alarm and Event Management, Scheduling, Trending, and Device Management.

Programmable

The dynamic memory of the bCX1-CR can be allocated for any combination of programs and BACnet object (including Schedules, Alarms, and Trends). Using the powerful Andover Plain English programming language, users can directly reference any BACnet object, either locally or globally. Our object-oriented Plain English, with intuitive keywords, provides

Features & Models	bCX1-R	bCX1-CR
Ports	3	3
Ethernet	10/100	10/100
Comm 1	Modem	Modem, Raw Port
Comm 2	MS/TP	MS/TP, Raw Port
Routing		
BBMD	Yes	Yes
BACnet/IP	Yes	Yes
BACnet over Ethernet	Yes	Yes
MS/TP	Yes	Yes
MS/TP Node Options	64	0, 8, 32, 64, 127
Flash Memory	Yes	Yes
xP Expansion I/O	No	2+Display
Plain English	No	Yes
Email Support	No	Yes
Web		
Basic Configuration	Yes	Yes
Embedded Web Server	No	Yes
SNMP		
SNMP Monitoring	Yes	Yes
SNMP Alarming	No	Optional
BACnet Device Profile	Router Only	B-BC
BTL Listed	No	

an easy method to tailor the controller to meet your exact requirements. As a programmable controller, the bCX1-CR can locally support a wide range of BACnet objects including BACnet loops, trends, and schedules. Plain English programs may be created to program coordinated control strategies, giving you the freedom to move data between third-party devices that do not have the peer-to-peer functionality provided in all Andover Continuum controllers.

Embedded Web Server

With the power of Plain English, custom HTML web pages can be created and embedded into the bCX1-CR to provide a simple-to-use, browser-based interface for monitoring or changing data points.

Expansion I/O

The bCX1-CR contains an I/O expansion port for the addition of up to two xP expansion modules plus a display directly on the bottom of the controller. The xP family of modules includes the xPD18, xPDO2, xPDO4, xPAO2, xPAO4, xPUI4, xP Local Display, as well as the xPBD4, and xPBA4 expansion modules, which can only be used with the bCX1.

SNMP Alarming Support

All bCX1 controllers are compatible with SNMP monitoring tools, which allow the controller to be interrogated for basic SNMP information. The -CR model features advanced SNMP alarm functionality as an option (-SA), providing alarm delivery for any device on the MS/TP network it manages.

System Controllers

920





The b4920 is a powerful system controller that also performs all the functions of a BACnet/IP-to-BACnet MS/TP router, routing messages from the Ethernet network to the field controllers. The b4920 provides built-in I/O, which is expandable if additional points are required. Acting as a BACnet Advanced Application Controller (B-AAC), the b4920 has the ability to talk to other Ethernet BACnet IP or BACnet MS/TP devices.

Specifications	b4920
Ethernet Port – BACnet/IP	10/100
RS-485 Port – BACnet/MSTP	Yes
UI (0-10 Volts) – 12 bit	16
Smart Sensor/Room Sensor Input	1
DO–Form C Relay; 3A, 24VAC	8
AO (0-10V, 0-20mA)–8 bit	8
Expansion I/O Port	Yes
Local Service Port	Yes
Real Time Clock	Yes
Flash Memory Size Application	512k
4-Line, 16-Character Display	Optional
BACnet Device Profile	B-AAC
BTL Listed	

800 SERIES



The b3800 series is perfect for the small Air Handling Unit/Roof Top controller. The b3800 and b3804 feature a built-in 24 VAC and 12-24 VDC auto sensing power supply.

Specifications	b3800	b3804
RS-485 Port – BACnet/MSTP	Yes	Yes
UI (0-5 Volts) – 10 bit	8	8
Smart Sensor/Room Sensor Input	1	1
DO – Form C Relay; 3A, 24 VAC	8	4
AO (0-10 Volts) – 8 bit	–	4
Expansion I/O Port	–	–
Local Service Port	Yes	Yes
Flash Memory Size (Application)	128k	128k
BACnet Device Profile	B-AAC	B-AAC
BTL Listed		

920





No Air Handling Unit is too big for the b3920 System Controller. The largest of the stand-alone controllers with 512k of memory. Built-in Real Time Clock plus support for additional I/O for larger applications.

Specifications	b3920
RS-485 Port – BACnet/MSTP	Yes
UI (0-10 Volts) – 12 bit	16
Smart Sensor/Room Sensor Input	1
DO–Form C Relay; 3A, 24VAC	8
AO (0-10V, 0-20mA)–8 bit	8
Expansion I/O Port	Yes
Local Service Port	Yes
Real Time Clock	Yes
Flash Memory Size Application	512k
4-Line, 16-Character Display	Optional
BACnet Device Profile	B-AAC
BTL Listed	

810 SERIES



The b3810 and b3814 provide the same power as the b3800 series, but also include wider-range universal inputs, additional memory, removable terminal blocks, HOA switches, and expansion I/O capability.

Specifications	b3810	b3814
RS-485 Port – BACnet/MSTP	Yes	Yes
UI (0-5 Volts) – 10 bit	8	8
Smart Sensor/Room Sensor Input	1	1
DO – Form C Relay; 3A, 24 VAC	8	4
AO (0-10 Volts, 0-20mA) – 8 bit	–	4
Expansion I/O Port	–	–
Local Service Port	Yes	Yes
Real Time Clock	Yes	Yes
Flash Memory Size (Application)	256k	256k
BACnet Device Profile	B-AAC	B-AAC
BTL Listed		

Terminal Controllers

b3 885



The b3885 is a cost-effective, reduced point-count VAV controller with a built-in actuator. It includes the same CPU used on all b3 controllers, plus Flash memory provides storage of both the operating system and the application program.

Specifications	b3885
RS-485 Port – BACnet/MSTP	Yes
UI (0-5 Volts) – 10 bit	2
Smart Sensor/Room Sensor Input	–
Airflow Sensor (0-1")	1
Damper Actuator	1
DO – Form A Triac; 0.5A, 24 VAC	2
Expansion I/O Port	–
Local Service Port	Yes
Flash Memory Size (Application & OS)	512k
BACnet Device Profile	B-AAC
BTL Listed	

Notes: No on-board battery
No Supervised Inputs

b3 887/887-L



The b3887 is a unique, low-cost, general-purpose terminal controller designed for Fan Coil and Heat Pump applications. The standard b3887 model uses 24 VAC input power; the b3887-L version is designed to use incoming line voltage at 115/230 VAC.

Specifications	b3887	b3887-L-115	b3887-L-230
RS-485 Port – BACnet/MSTP	Yes	Yes	Yes
Supply Voltage	24 VAC	115 VAC	230 VAC
UI (0-5 Volts) – 10 bit	3	3	3
Smart Sensor/Room Sensor Input	1	1	1
DO – Form A Triac; 0.3A, 24 VAC	4	4	4
DO – Form A Relay; 3A, 277 VAC	1	1	1
Expansion I/O Port	–	–	–
Local Service Port	Yes	Yes	Yes
Flash Memory Size (Application & OS)	512k	512k	512k
BACnet Device Profile	B-AAC	B-AAC	B-AAC
BTL Listed			

Notes: No on-board battery
No Supervised Inputs
-C = Closed class version

b3 865/866



The b3865 and b3866 are full-featured VAV controllers that come equipped with a built-in actuator. Compared to the b3885, the b3865 series provides more I/O to handle your full range of VAV applications.

Specifications	b3865	b3866
RS-485 Port – BACnet/MSTP	Yes	Yes
UI (0-5 Volts) – 10 bit	4	4
Smart Sensor/Room Sensor Input	1	1
Airflow Sensor (0-2")	1	1
Damper Actuator	1	1
DO – Form A Triac; 0.5A, 24 VAC	3	3
AO (0-10 Volts) – 8 bit	–	2
Expansion I/O Port	–	–
Local Service Port	Yes	Yes
Flash Memory Size (Application)	128k	128k
BACnet Device Profile	B-AAC	B-AAC
BTL Listed		

b3 867



The b3867 is a compact terminal controller that provides DDC control of package units, heat pumps, unit ventilators, and other terminal unit applications. Compared to the b3887, the b3867 provides more I/O for greater flexibility.



Specifications	b3867
RS-485 Port – BACnet/MSTP	Yes
UI (0-5 Volts) – 10 bit	4
Smart Sensor/Room Sensor Input	1
DO – Form A Triac; 0.5A, 24 VAC	5
AO (0-10 Volts) – 8 bit	2
Expansion I/O Port	–
Local Service Port	Yes
Flash Memory Size (Application & OS)	128k
BACnet Device Profile	B-AAC
BTL Listed	

Terminal Controllers (continued)

b3 850 SERIES



The b3850 series is a perfect fit for your VAV applications where external actuators are used. If additional I/O points are required, the built-in I/O Expansion Port provides the link and the module power for these points. The b3853 is designed for dual-duct VAV applications that require two airflow sensors.

Specifications	b3850	b3851	b3853
RS-485 Port – BACnet/MSTP	Yes	Yes	Yes
UI (0-5 Volts) – 10 bit	4	4	4
Smart Sensor/Room Sensor Input	1	1	1
Airflow Sensor/(0-2")	1	–	2
DO – Form A Relay; 3A, 24 VAC	3	3	3
DO – Tri-State Form K; 3A, 24 VAC	1	1	1
Expansion I/O Port	Yes	Yes	Yes
Local Service Port	Yes	Yes	Yes
Flash Memory Size (Application)	128k	128k	128k
BACnet Device Profile	B-AAC	B-AAC	B-AAC
BTL Listed			

xP EXPANSION I/O



When additional I/O points are required, the I/O Expansion Family of attachable modules are available to solve all your application needs. The b3810, b3850, b3920, and the bCX1-CR series controllers support up to two I/O Expansion modules and/or a remote mounted display.

EXP. MODELS: PROVIDES ADDITIONAL:

xPDI8	8 Digital Inputs
xPUI4	4 Universal Inputs
xPAO2	2 Analog Outputs with overrides
xPAO4	4 Analog Outputs with overrides
xPDO2	2 Digital Outputs with overrides
xPDO4	4 Digital Outputs with overrides
xP Display	Local Display Module (4-Line, 16-Character)



In addition to the standard xP modules available for the field controller, two new modules have been developed to enhance the functionality of the bCX1-CR Building Controller.

xPBD4	4 Universal Inputs 4 Digital Outputs with overrides 4 Analog Outputs with overrides
-------	---

b3 600 SERIES



The b3600 Series is ideal for small or large groups of inputs that require monitoring in a concentrated area. Equipped with a built-in 24 VAC and 12-24 VDC auto sensing power supply, the unit allows any Universal Input to be configured as a Supervised Input for monitoring open wires or short circuits.

Specifications	b3608	b3624
RS-485 Port – BACnet/MSTP	Yes	Yes
UI (0-5 Volts) – 10 bit	8	24
Smart Sensor/Room Sensor Input	–	–
Expansion I/O Port	–	–
Local Service Port	Yes	Yes
Flash Memory Size (Application)	128k	128k
BACnet Device Profile	B-AAC	B-AAC
BTL Listed		

Expanded BACnet Architecture

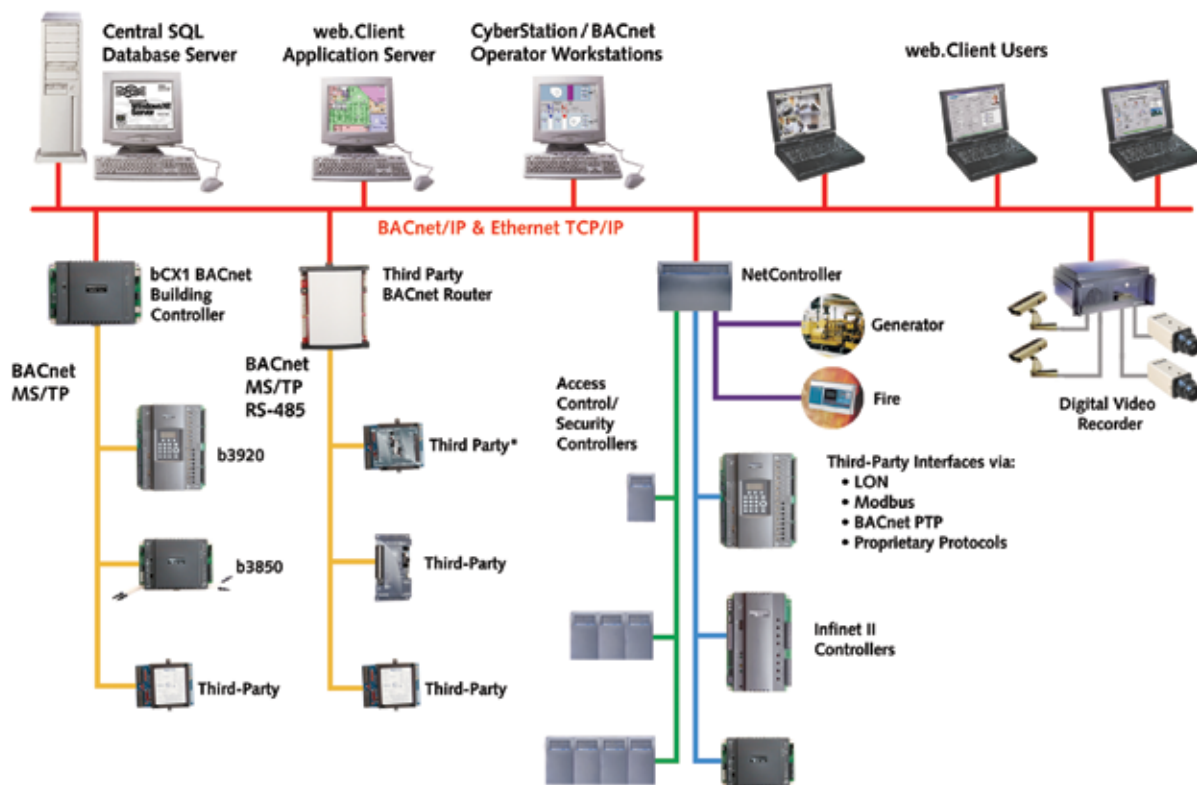

Copyright © 2006, TAC
 All brand names, trademarks and registered trademarks are the property of their respective owners. Information contained within this document is subject to change without notice. All rights reserved.

SDS-BACNETFAM-US
 03/06



www.tac.com

